



Installing software for multiple wavelength meters or even two versions for the same instrument is possible.

Legacy software or instruments may experience compatibility issues. Please receive support from customer service in such cases.



HighFinesse GmbH
Wöhrdstraße 4
72072 Tübingen/Germany

T +49 (0) 7071 - 53 918 0
F +49 (0) 7071 - 53 918 99
M info@highfinesse.com

www.highfinesse.com

This Quick Start Guide is also available on our website:



www.highfinesse.com/quick-start-guide

Have a look to
the complete product
portfolio of HighFinesse



Spectrometer

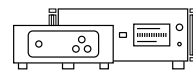

Linewidth Analyzer

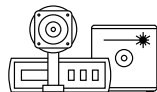

Calibration
Sources



Precision
Current Sources

www.highfinesse.com



Quick Start Guide HighFinesse Wavelength Meter



WS Series

Connection to light source
via **multimode switch**

Please note:

Some optional features require separate hardware parts. Please make sure to assemble them before software installation!

1

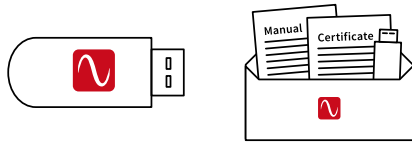

The **installation software** is deployed on a flash drive. It's stored in the **envelope** that contains the manual and certificate.

2



Start »setup.exe«

Express Setup – Automatic installation, simply follow the prompts.

Custom Setup – For advanced users desiring custom settings. Follow the prompts.

3

Connect Wavelength Meter and Computer

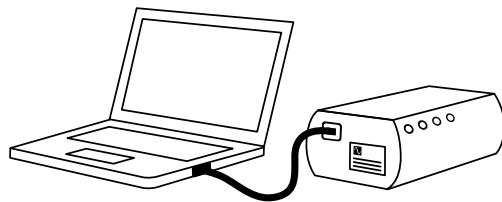

Some wavelength meters have an external power supply. Please connect the power supply before connecting the USB cable (included in shipment).

Please avoid using USB cables longer than 3 meters – that might cause communication protocol difficulties with Windows.

4

Connect Wavelength Meter and Light Source via a Multimode Switch

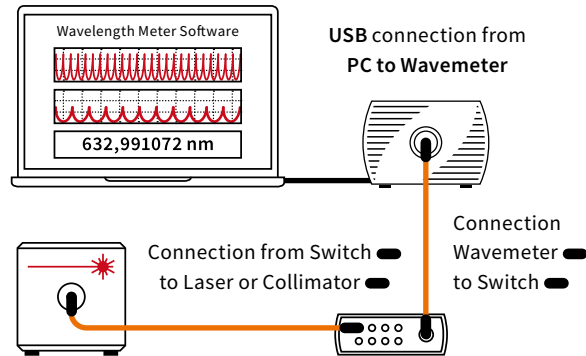

⚠ Please note: Pay attention to the damage thresholds specified in the switch manual. A few μJ (μW @ 1s exposure) or even less are usually enough to achieve a measurement. Take special care when working with pulsed lasers.

Suitable patchcords:

All wavelength meters feature FC/PC sockets.

Use the patchcord between **wavemeter and switch** and between **switch and laser**.

Your measurement results will be impaired when you apply FC/APC connectors to a wavelength meter input.

5



Start software

Simply run the desktop shortcut.

6

Start Measurement

Depending on your light source adjust the software settings in the graphical user interface.

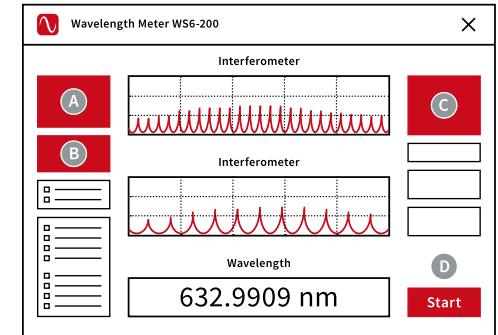

A Select preferred unit

B Select **pulsed** or **continuous**

C Adjust exposure **manually** or select **“Automatic”**

D Start the measurement

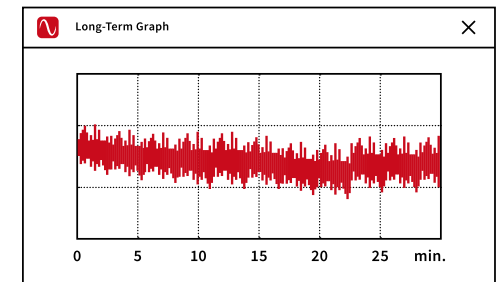

The **Long-Term program** is set to **automatically start with the measurement**. After completion of your measurement save the long-term data on your computer. You can **reload at any later time** or use the **data with any other statistical program**.